



HIGH-SPEED, HIGH-PRODUCTIVITY
HORIZONTAL MACHINING CENTER

NHP

5500

2nd Generation

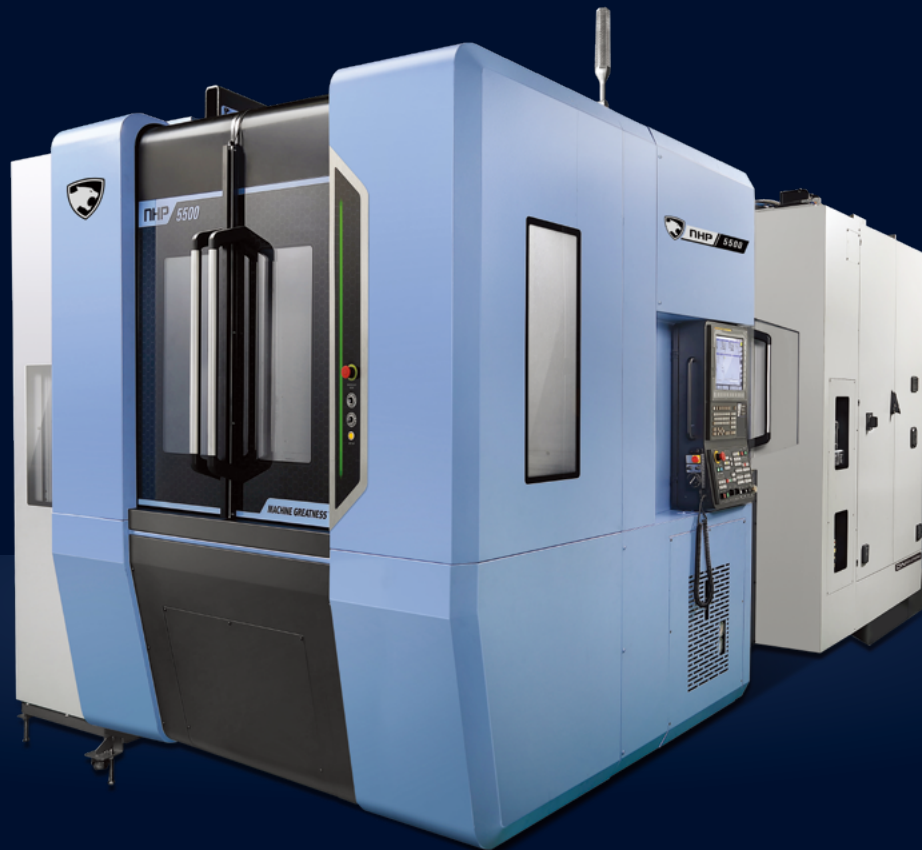

DN SOLUTIONS

NHP 5500 2nd Generation

NHP 5500^{2nd} considerably improved the productivity with faster X/Y/Z feed acceleration/deceleration, shorter tool change time and faster table rotation time. And it secured improved machining accuracy with spindle smart thermal control, X/Y/Z all axis ball screw shaft and nut cooling and 3-point support structure equipped as standard. Also provided are various automation solutions and the chip removal function, ensuring stable continuous machining for long periods of time.

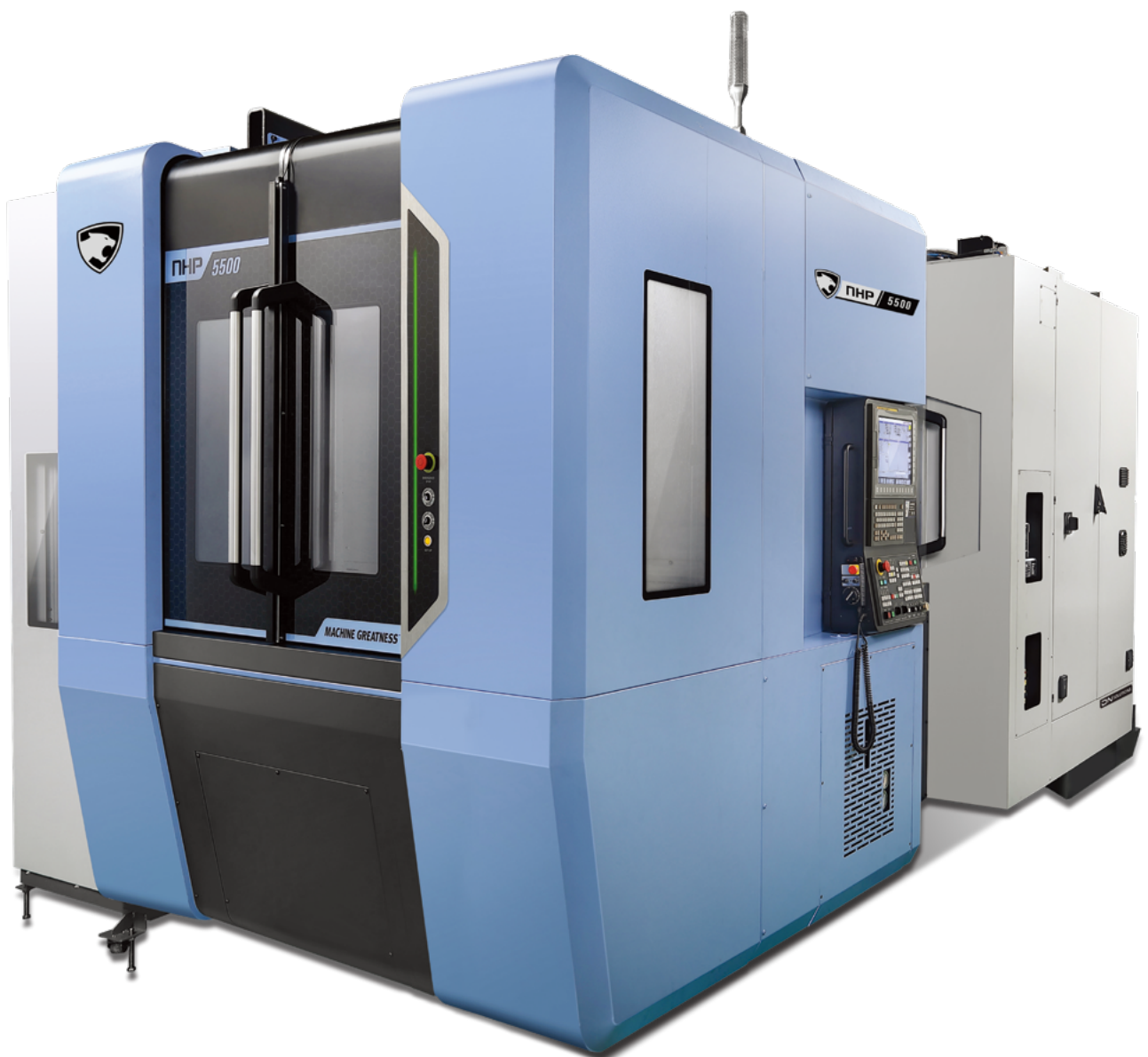



ENHANCED PRODUCTIVITY

- Higher productivity and the minimum non-cutting time are accomplished through Y/Z feed axes acceleration and deceleration of more than 1G (X/Y/Z acc/dec 0.91/1.07/1.02G respectively), rapid traverse rate of 60m/min and the short tool change time (T-T-T) of 1.7 seconds.

LONG-LASTING HIGH PRECISION

- Long-term, high-precision machining is ensured on a stable basis through such features as 37KW built-in spindle equipped with the thermal displacement sensor, X/Y/Z high-speed, high-precision roller LM guide with a ball screw shaft and nut cooling function applied in the standard model and a 3-point support-type bed structure.

VARIOUS AUTOMATION SOLUTIONS/CONVENIENCE FUNCTIONS

- Expandable up to 72 pallets using the LPS or RPS pallet automatic changer, and the hydraulic/pneumatic fixture line can be built into the table of the pallet bottom.

BASIC STRUCTURE

A high level of precision can be achieved on a stable basis thanks to the 3-point support type bed structure and the X/Y/Z ball screw shaft and nut cooling function.

Travel distance

X axis
800 mm
31.5 inch

Y axis
750 mm
29.5 inch

Z axis
900 mm
35.4 inch

Feed axis acceleration/deceleration

X axis
0.91 g

Y axis
1.07 g

Z axis
1.02 g

Rapid traverse rate

60 m/min
2362.2 ipm

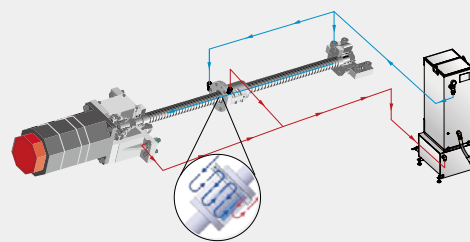
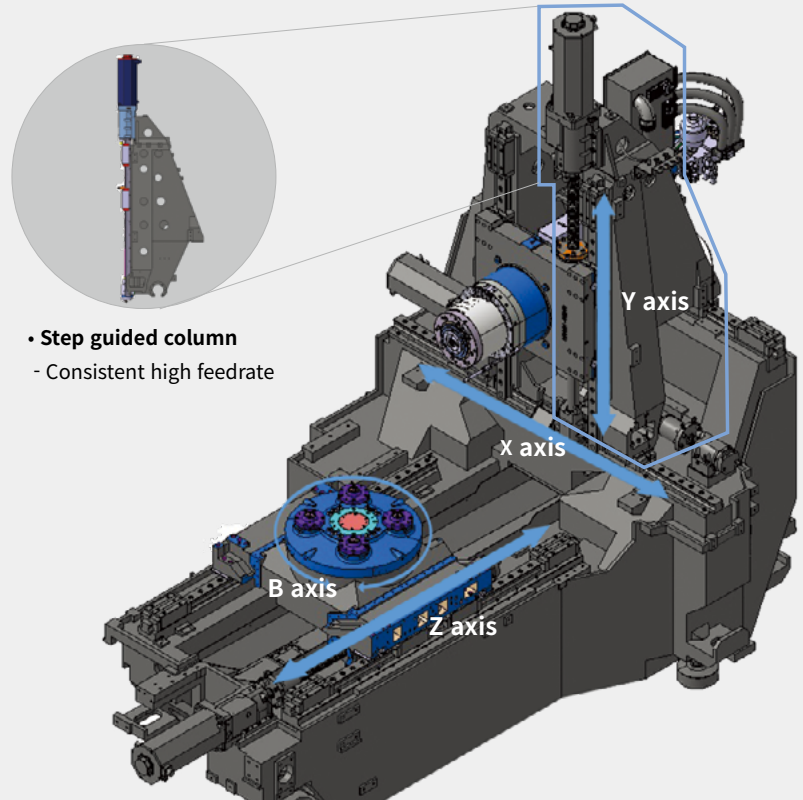

- **Ball screw shaft and nut cooling**
- Reduced thermal displacement for feed axis and consistent high precision

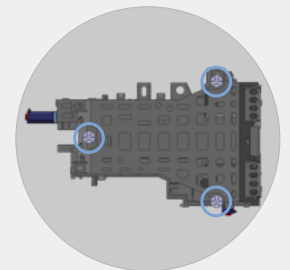

- **3-point support type bed structure**
- Leading to the positional stability of the machine ensuring accuracy

Fast precision X/Y/Z/ feed structure

Productivity has been greatly increased with the high-speed, high-precision roller type LM guideway installed for X/Y/Z entire axes and the acceleration/deceleration performance of more than 1G

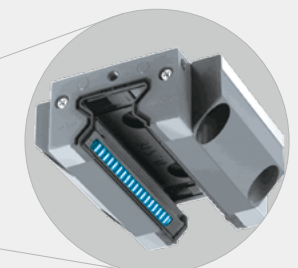
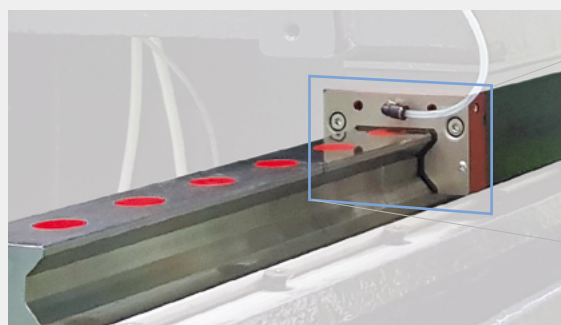

High-rigidity, high-precision roller type LM guideway

TABLE

Rotary shuttle-type pallet changer can be operated on a stable and accurate basis, enhancing its reliability.

Max. workpiece size

Ø900 x H1100 mm
35.4 x 43.3 inch

Machinable work size is enlarged in comparison with the previous model by increasing the efficiency of machine interior space (while reducing the space of installation).

Max. workpiece weight (W)

800 kg 1763.7 lb
1000 kg 2204.6 lb option

Pallet change time

12 sec, **15** sec option

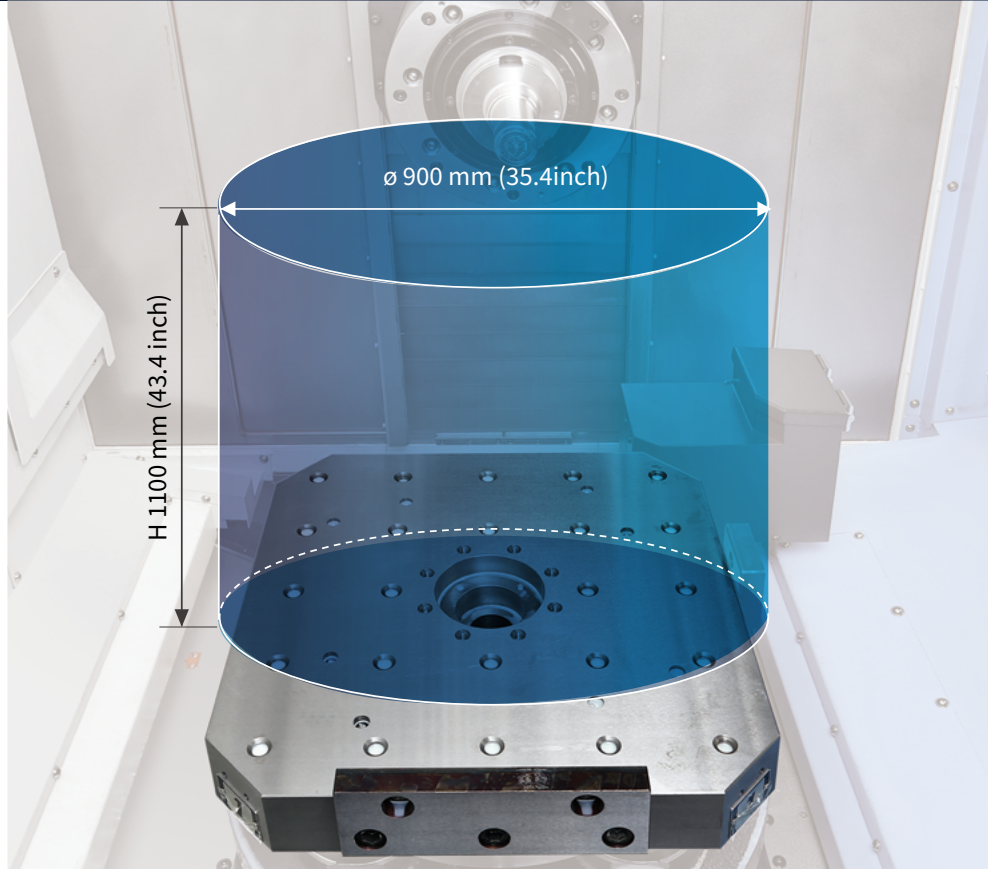

Table rotation (B axis)

1° control index table:
Capable of high-speed rotation; 90 degrees 1.1 seconds and 180 degrees 1.5 seconds

0.0001 degrees RGC* type rotary table option:
Max. allowable rotative speed 30 r/min

0.0001 degrees DDM** type rotary table option:
Max. allowable rotative speed; high speed 100 r/min

*Roller Gear Cam

**Direct Drive Motor

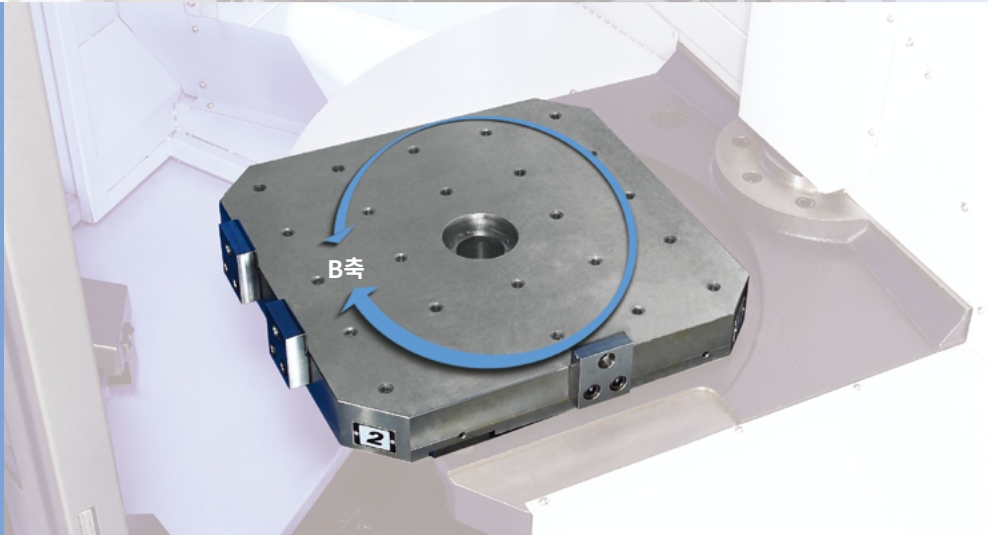

Cone Air Blower

As a mechanism designed for precise pallet position repeatability, the air blower injects high pressure air into the location cones connecting the table to the pallet. This removes chips from the locating surfaces and ensures highly accurate pallet positioning.

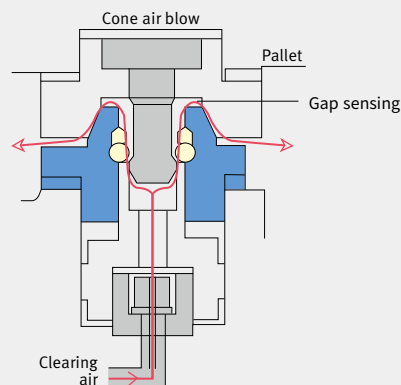

SPINDLE

This built-in spindle minimizes the occurrence of vibration and heat generation. It's equipped with sensor-type spindle smart thermal error compensation, providing excellent high-speed, high-precision cutting performance.

Spindle cooling system (oil cooler) available in the standard model

Max spindle speed

10000 r/min

15000 r/min option

Spindle tool taper

ISO #50

Max. spindle motor power

37 kW 49.6Hp

45 kW 60.3Hp (High Torque) option

Max. spindle motor torque

516 N.m 380.8 ft-lbs

644 N.m option

475.3 ft-lbs (High Torque)

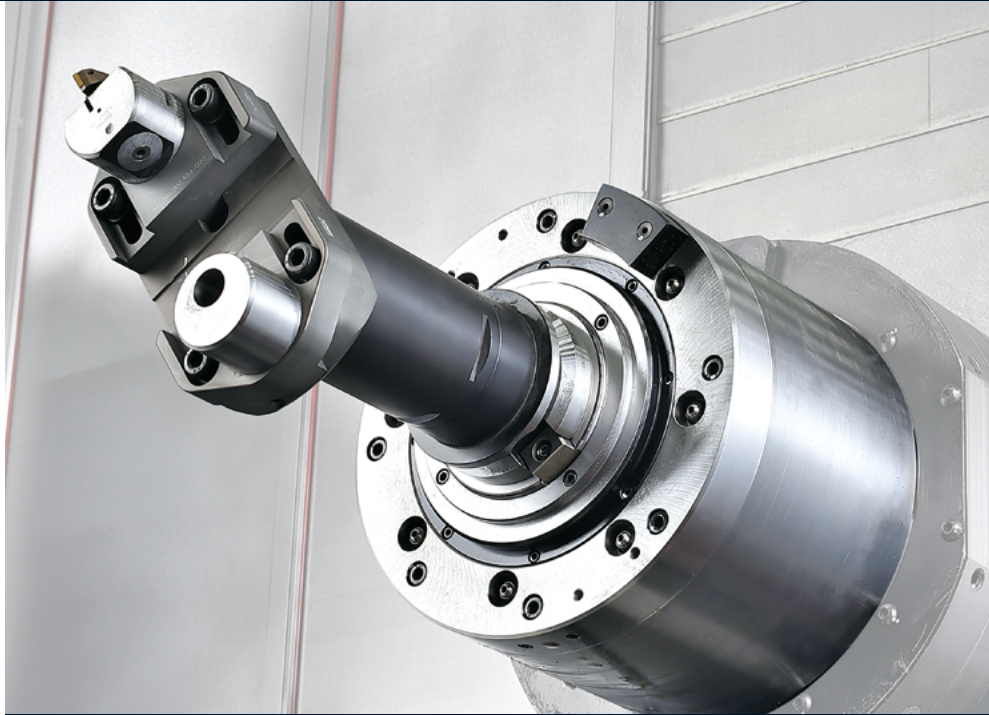

Spindle Cooling System

An oil cooler system is provided as a standard feature for long-term, continuous operation at high speeds. The oil is cooled down in the cooler before circulating around the spindle bearings and built-in motor to minimize thermal error and deliver high-precision cutting.

High-Speed, high-precision spindle

Designed to minimize vibration and thermal error while offering rapid acceleration and deceleration, the spindle guarantees excellent cutting performance from steel to nonferrous metal parts. Thanks to its increased rigidity, the spindle supports various machining from high speed cutting to low speed heavy cutting.

Spindle cooling system and spindle smart thermal control function available in the standard model

The oil cooler system as well as the spindle thermal error compensation function is provided in the standard model to keep the level of spindle heat generation and thermal error to a minimum.



MAGAZINE

Varied types of the tool magazine are provided for enhanced customer convenience.

Tool changer

Tool magazine capacity

40 ea

{60, 90, 120, 150, 196, 256, 316, 376} option

Tool change time

Tool To Tool(T-T-T) **1.7** sec
Chip To Chip(C-T-C) **4.7**sec

Max. tool length

550 mm 21.7 inch (BT/CAT/DIN)

640 mm 25.2 inch (HSK)

Max. tool weight

25 kg 55.1 lb (40/60T)

30 kg 66.1 lb (More than 90T)

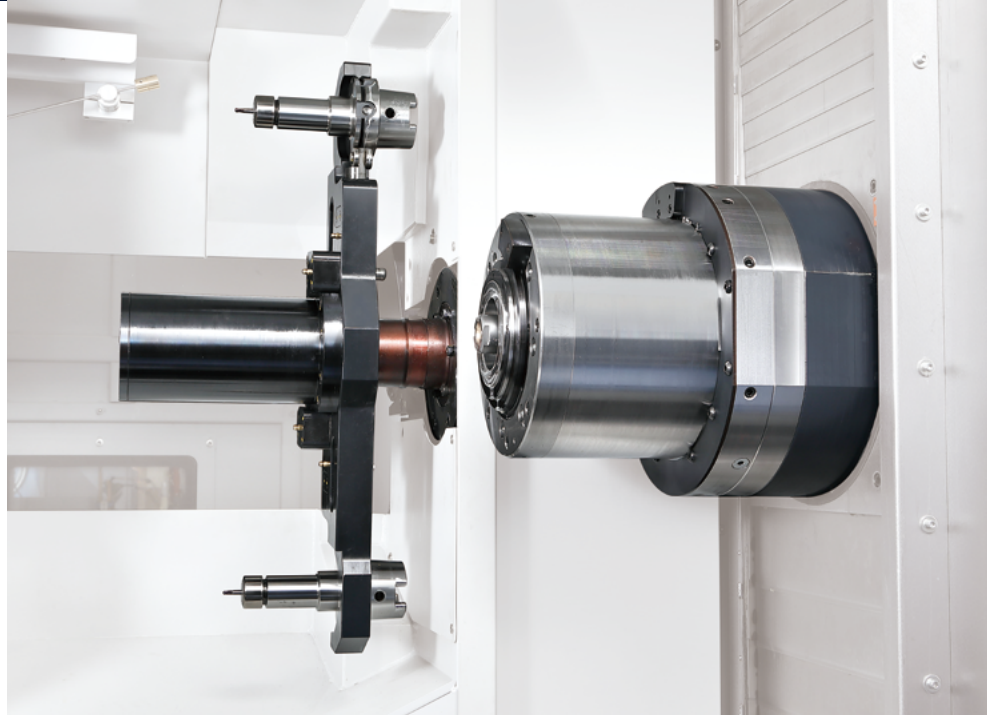

Servo-driven ATC

The ATC is capable of handling pot-type tools weighing up to 25kg and chain-type tools weighing up to 30kg at high speeds using a servo motor and fast tool indexing and spindle positioning.

Tool Magazine type

Pot type magazine

40 / 60 tools option

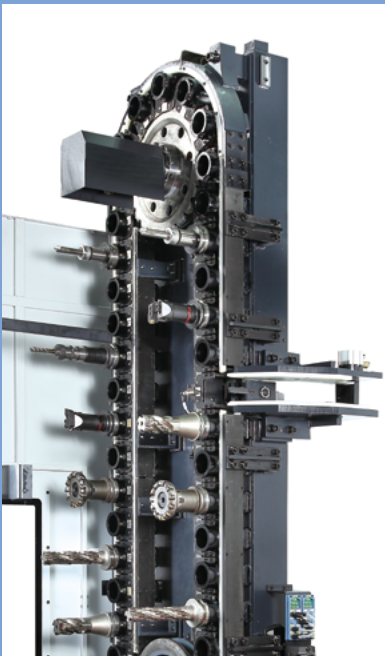

Chain type magazine option

90 / 120 / 150 tools

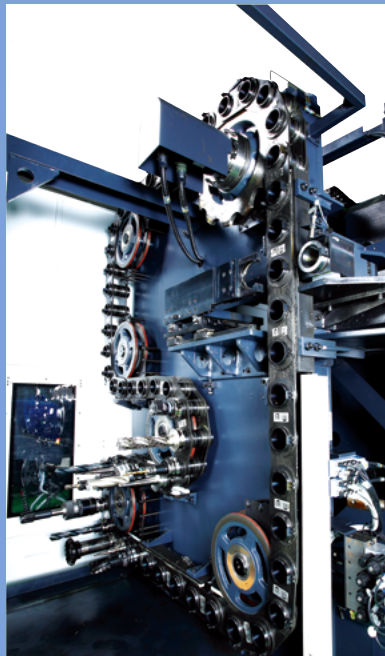

Matrix type magazine option

196 / 256 / 316 / 376 tools



HIGHER ACCURACY PACKAGE

Going a step further to a higher level of machining accuracy can be achieved by selecting the “Higher Accuracy Package” during high precision machining, i.e. for eco-friendly vehicles, aviation and precision machinery requiring stricter machining tolerance.

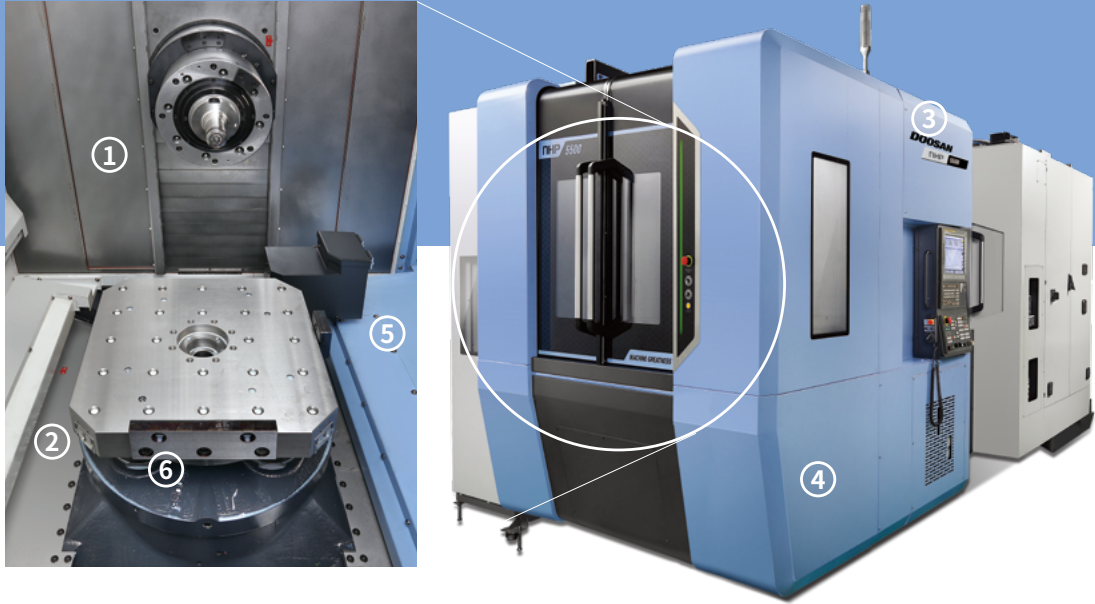

1. Structure smart thermal control

- X/Y/Z structural thermal displacement less than $7\mu\text{m}$

Less than $7\mu\text{m}$

(Measuring thermal displacement when atmospheric temperature varies by 6 degrees for 40 hours)

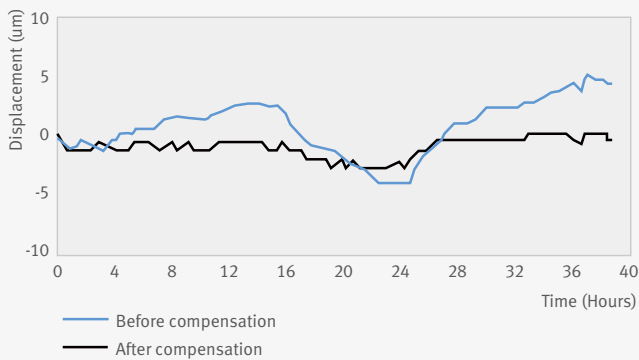

* The results, indicated in this catalogue are provides as example. They may not be obtained due to difference in cutting conditions and environmental conditions during measurement.

3. Mist collector



4. Coolant chiller

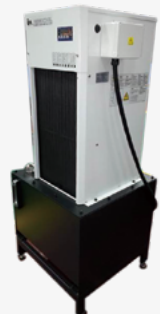

2. X/Y/Z linear scale

- X/Y/Z all axes
- Retaining long-term positioning and repetition accuracy



5. Strict manufacturing process to realize high precision

- Special heat treatment (Body Frame)
- Enhanced precision maintenance for each assembly process

6. Pallet clamp confirmation

STANDARD | OPTIONAL SPECIFICATIONS

A range of options is available to suit individual requirements.

● Standard ○ Optional x Not applicable

Description	Features	NHP 5500 2 nd Generation
Tool magazine	40-tool pot type	●
	60-tool pot type	○
	90/120/150 tools_ Chain type	○
	196/256/316/376 tools_ Matrix type	○
	Tool ID (Balluff sensor)	○
	Tool management function (TMT1/2/8 digit)	○
Tool shank type	BT50	●
	CAT50/DIN50/HSK-A100	○
Mist collector	Mist Collector	○
Spindle	10000 r/min, 37/26 kW	●
	10000 r/min, High Torque 45/26 kW	○
	High speed 15000 r/min, 37/30 kW	○
	Spindle air curtain	●
	U-axis drive (D'ANDREA TA-C160/200)	○
Hydraulic fixtures	Upper hydraulic lines 2X2, 4X4, 6X6, 8X8	○
	Lower hydraulic lines setup part max. 8 ports; table part 2 ports	○
	Hydraulic fixture unit	○
Automation	LPS (Linear Pallet System); 12 to 72 pallets	○
	LPS (Linear Pallet System); 7 to 9 pallets	○
Automatic workpiece measurement	OMP60	○
	RMP60	○
Automatic tool measurement device	TS27R, RMI-Q, TRS2, NC 4_Renishaw	○
	D5A_OMRON	○
	FEM 1CP_Far East Machine Tool	○
	BK9_MSC	○
Accuracy	Linear scale (X/YZ axes)	○
	Spindle smart thermal control	●
	Structure smart thermal control	○
	Ball screw shaft cooling	●
Chip Handling System	Scrapper type; Drum chip conveyor	○
	2-step drum chip conveyor	○
	Internal chip conveyor (Screw type)	○
	Chip bucket	○
Coolant	Flood (50Hz: 1.1kW 1.0MPa / 60Hz: 1.1kW 0.75MPa)	●
	Flushing (50Hz: 2.5kW 0.32MPa / 60Hz: 2.5kW 0.22MPa)	●
	Shower (Sharing the motor with 'Flood')	○
	TSC_1.5 kW (50Hz: 2.0MPa / 60Hz: 1.9MPa)	○
	TSC_3.7 kW (50Hz: 3.0MPa / 60Hz: 2.9MPa)	○
	TSC_7.5 kW (50Hz/60Hz: 7.0MPa)	○
	Coolant gun	○
	Oil skimmer	●
	MQL system	○
	Coolant chiller unit	○
	Coolant level switch, Sensing level; Low/High	○
Table	Index table (1° control)	●
	Rotary table (0.001 control, RGC type)	○
	Rotary table (0.001 control, DDM type)	○
Pallet	Tap Pallet	●
	T-slot pallet	○
	Max. allowable weight increased (800kg --> 1000kg)	○
AIR	Pallet air clamping (Ensuring clamping)	○
	AIR GUN	○
Convenient Function	SPIN WINDOW (ELECTRIC TYPE)	○
	APC-set up auto indexing	○
	Setup shower coolant	○

* Please contact DN Solutions to find out more about specifications and options

 **Fire Safety Precautions** | There is a high risk of fire when using non-water-soluble cutting fluids, processing flammable materials, neglecting the controlled and careful use of coolants and modifying the machine without the consent of the manufacturer. Always check the SAFETY GUIDELINES carefully before using the machine.

PERIPHERAL EQUIPMENT

Chip Conveyor option

Chip disposal is very important to productivity and the work environment. To meet this requirement, the NHP Series enhances chip disposal performance, thus improving the work environment.



Scraper type drum chip conveyor



Eco-Friendly Devices



Oil skimmer



Mist collector option

Chip disposal solution

A solution for smooth chip disposal is provided to prevent any deterioration in accuracy and productivity caused by the chips that are stuck or piled up

Chip Removal System



FLUSHING COOLANT

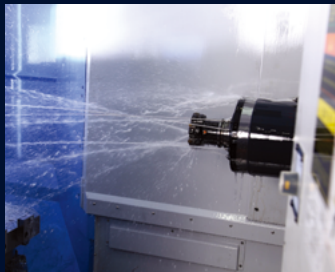

FLOOD COOLANT



SHOWER COOLANT option



COOLANT GUN option



COOLANT FLUSHING ON THE SPINDLE HEAD



SPINDLE-THROUGH COOLANT (TSC) option



MQL SYSTEM option :SPRAYING ECO-FRIENDLY OIL MIXED WITH AIR, INSTEAD OF CUTTING OIL

PERIPHERAL EQUIPMENT

Measuring Devices

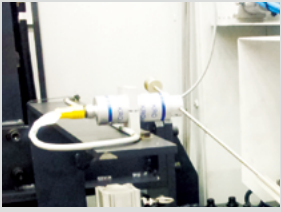

Auto tool damage detection device I (BK 9) **option**

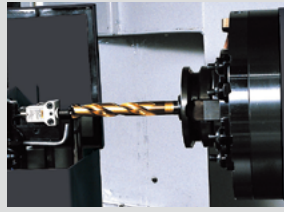

Auto tool damage detection device II (OMRON) **option**



Automatic tool measuring device (TS 27R) **option**

Coolant Chiller **option**



Linear scale available in the standard model **option**

- X/Y/Z all axes
- Retaining long-term positioning and repetition accuracy



Spindle Smart Thermal Control (Std.) Structure Smart Thermal Control **option**

Structure (Bed, column, X-axis base)
thermal error stabilized

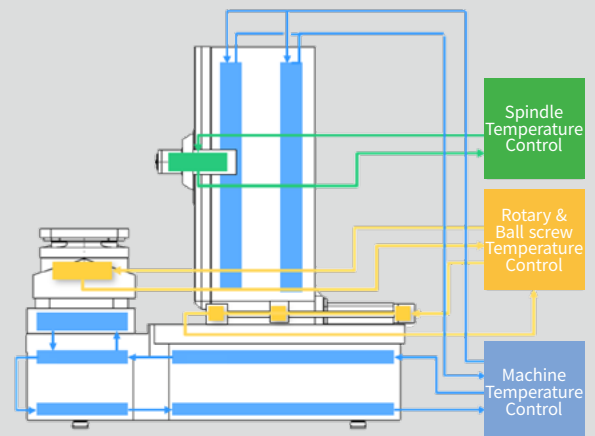

SFC(Sludge Free Coolant tank) **option**

This coolant tank system is intended for automatically eliminating the fine chips and sludge deposited on the bottom of the tank.

- Preventing the sludge from being deposited by causing the coolant to flow.
- Collecting and separating sludge using the cyclone filter and the additional pump

- Extending coolant life (Cost saving)
- Reducing the frequency of cleaning (Machine operating ratio and productivity increased)
- Best suited for unmanned automation solutions

SFC system

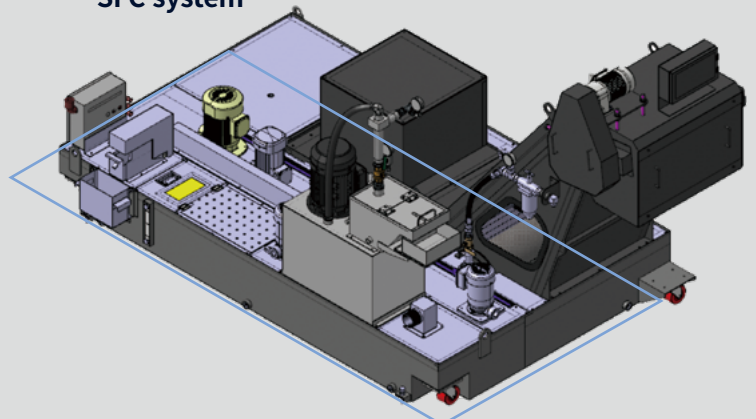

PERIPHERAL EQUIPMENT | CONVENIENT FUNCTIONS

This operator-oriented design is intended for providing the customer with convenience and safety.

User-oriented design

Internal footing and an anti-door-lock function are provided to prevent the operator from being locked in the machine and to guarantee the operator's safety. The installation of a centralized service unit and screen panel enhances the operator's convenience.

Coolant flushing on the spindle head to keep clean from chips over the spindle

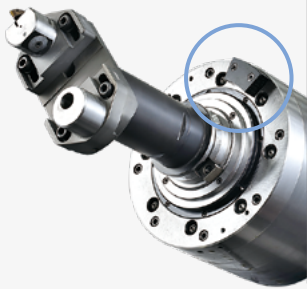

Centralized utility service unit

The utilities service unit is centralized for convenient maintainability.

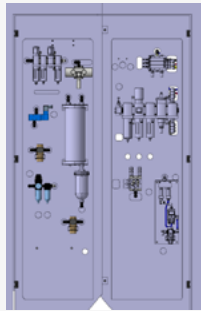

ATC screen panel



Anti-door lock device

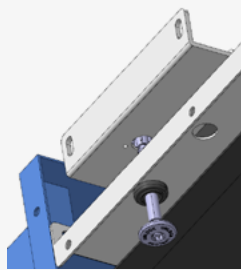

Spindle-through coolant spray device of semi-permanent service life, enabling convenient maintenance and cost saving

option



Safety has been improved with machine internal footings

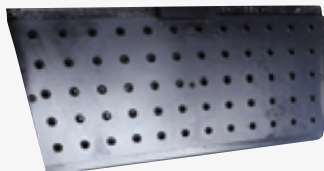

Application

We offer a wide range of solutions that can be optimized to suit each customer's needs.

Clamping Fixtures

The following hydraulic and pneumatic fixture options are available for setting up workpieces:

List of workpiece clamping fixtures (hydraulic/pneumatic) option

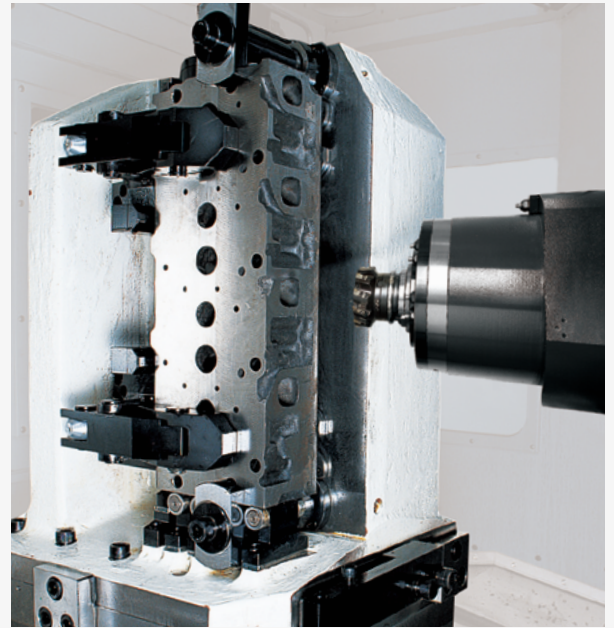

Hydraulic/pneumatic fixture pot Clamping fixture hydraulic

- | | |
|--|------------------------------------|
| • A/B Line : 2, 4, 6, 8 Pairs
(Including solenoid valve) | motor
•2.2 kW / 7MPa |
| • P/T Line : 2, 4, 6, 8 Pairs
(Solenoid valve not included) | •3.7 kW / 15MPa
•5.5 kW / 21MPa |

※Please provide us with detailed specifications on the order sheet

Hydraulic/pneumatic fixture lines on the pallet bottom

Hydraulic/pneumatic fixture lines can be built into the table of the pallet bottom to increase the efficiency of the machine interior space, creating a safer working environment.

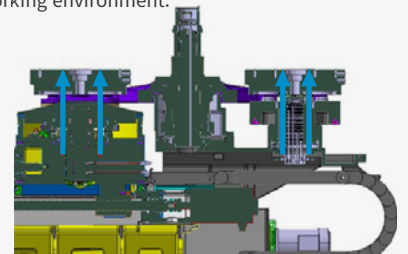

LINEAR | ROUND PALLET SYSTEM

Expandable!



LPS 5500

LPS 5500 are wonderfully designed, allowing them to provide a high level of automation system for the customers.

Features

- Servo-driven system providing reliability
- Easy to install
- Simple on-site modification

Improved Productivity

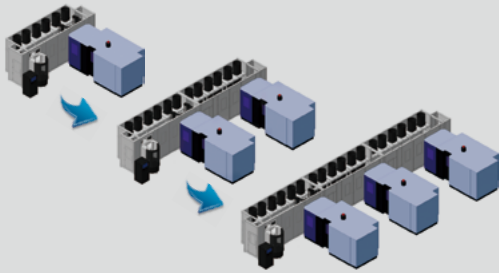

Extended automation run-time

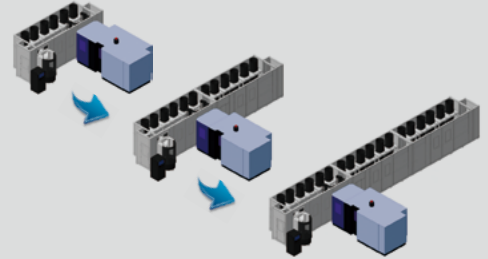

RPS 5500

Compact automation system for BT 50 HMC machines

Features

- Servo-driven system providing reliability
- Easy to install
- Simple on-site modification

Dimensions

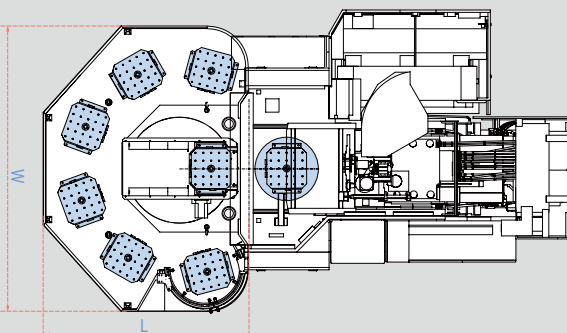

Models		Width (W)	Length (L)
NHP 5500	mm (inch)	3848 (151.5)	2674 (105.3)

FANUC 31i/32i PLUS

Fanuc 31i/32i Plus maximizes customer productivity and convenience.

15" Touch screen + New OP

DN Solutions Fanuc 31iB/B5 Plus' operation panel enhances operating convenience by incorporating common-design buttons and layout. It features a Qwerty keyboard for fast and easy data input and operation.

Fanuc 31i/32i Plus

- 15-inch color display
- Intuitive and user-friendly design

USB and PCMCIA card QWERTY keyboard

- EZ-Guide i standard
- Ergonomic operator panel
- 4MB Memory
- Hot keys
- Enhance AICC BLOCK
- Touch pen provided as standard



iHMI touchscreen

iHMI provides an intuitive interface that uses a touchscreen for quick and easy operation.

Range of applications

Providing various applications related to planning, machining, improvement and utility, for customer convenience.

NUMERIC CONTROL SPECIFICATIONS

FANUC

	Item	Specifications	F31iB PLUS
			NHP 5500 2 nd generation
Controlled axis	Controlled axes		4 (X,Y,Z,B)
	Simultaneously controlled axes		4 axes
	Additional controlled Axis	Add 1 Axis (5th Axis)	●
Data input/output	Fast data server		○
	Memory card input/output		●
	USB memory input/output		●
Interface function	Large capacity memory(2GB)*2	Note *2) Available Option only with 15" Touch LCD (iHMI Only)	○
	Embedded Ethernet		●
	Fast Ethernet		○
Operation	Enhanced Embedded Ethernet function		●
	DNC operation	Included in RS232C interface.	●
	DNC operation with memory card		●
Program input	Workpiece coordinate system	G52 - G59	●
	Addition of workpiece coordinate system	G54.1 P1 X 48 (48 pairs)	●
	Tool number command		T4 digits
Feed function	Tilted working plane indexing command	G68.2 TWP	○
	AI contour control I	G5.1 Q_, 40 Blocks	X
	AI contour control II	G5.1 Q_, 200 Blocks	X
	AI contour control II	G5.1 Q_, 600 Blocks	X
	AI contour control II	G5.1 Q_, 1000 Blocks	●*
Operation Guidance Function	High smooth TCP		X
	EZ Guidei (Conversational Programming Solution)		●
	iHMI with Machining Cycle	Note *1) Only with 15" Touch LCD standard	●
Setting and display	EZ Operation package		●
	CNC screen dual display function		●
Network	FANUC MT Connect		⊕
	FANUC OPC UA		⊕
Others	Display unit	15" color LCD	○
		15" color LCD with Touch Panel	●
		640M(256KB)_500 programs	X
		1280M(512KB)_1000 programs	X
		2560M(1MB)_1000 programs	X
		5120M(2MB)_1000 programs	X
		10240M(4MB)_1000 programs	●
		20480M(8MB)_1000 programs	○
		2560M(1MB)_2000 programs	○
		5120M(2MB)_4000 programs	○
	10240M(4MB)_4000 programs	○	
20480M(8MB)_4000 programs	○		
Part program storage size & Number of registerable programs			

EZ WORK

The software developed by DN Solutions features numerous functions designed for convenience and ease of operation.

EZ work

The EZ work package delivers speed and efficiency. This menu-driven innovation not only helps customers reduce setup times, but also simplifies common tasks and procedures, reducing the potential for errors. EZ work reduces operating time, protects machinery, enhances quality and speeds up maintenance interventions.

Tool support functions



Tool management I

- Tool magazine control
- Tool state display
- Fastems Tool Add/Remove Function option



Tool management II option

- Tool magazine control
- Tool life management
- Tool life prediction
- Tool state control
- Balluff Tool ID function



Tool load monitor option

- Detection of tool damage
- Detection of abnormalities during operation
- Detection of no-load air cutting

Productivity improvement functions



Adaptive Feed Control

Function to control feedrate so that the cutting can be carried out at a constant load



APC Setting Screen

A simple automation function that supports automatic processing of the next pallet by setting the processing program for each pallet of the equipment including APC in advance



Work Load Control

Optimal machining values can be automatically entered into parameters according to the weight of the workpiece placed on the table



PMC Soft Panel Switch

Manual operations that occur continuously in each stages for APC, ATC change command

Operation support, Help desk functions



Operation rate

- Measure various machine operating rate
- Support 3 shift operation
- calculate and save 30 days operating rate
- Show data for a specific period

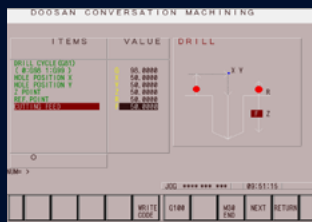

Pattern Cycle

A function to automatically create frequently used part programs.



Renishaw GUI

Renishaw tool length measuring and compensate function



Spindle Warm Up

A function that assists spindle warm-up for spindle life when the spindle has not been used for a certain period of time

CONVENIENT OPERATION

SIEMENS 840D

15.6" screen + new operation panel

The newly-designed operation panel improves the customer convenience by incorporating and using common-design buttons and layouts, and includes the familiar QWERTY keyboard for fast and easy operation.

- Provide 15.6" wide screen in the standard model
- 10MB high capacity user memory
- USB & ethernet (standard)
- QWERTY keyboard (standard)
- High-speed calculation and simulation can be fulfilled by improved processor functionality



Conversational convenient function

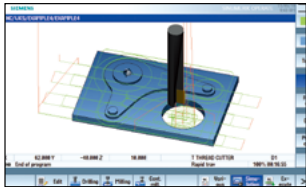

Simulation and machining contour monitoring

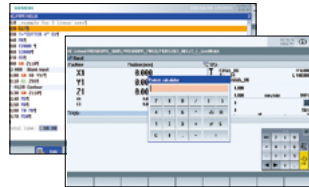

Smart function

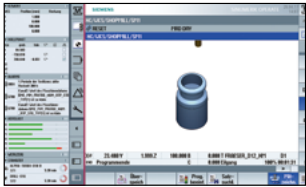

Side screen widget

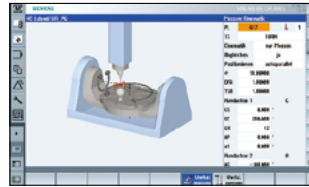

5-axis kinematic measuring cycles

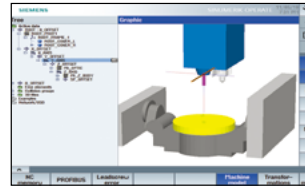

3D collision avoidance and collision avoidance ECO

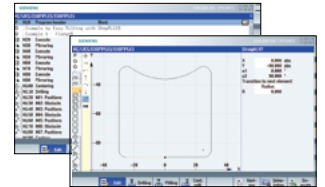

Shop mill part programming

NUMERIC CONTROL SPECIFICATIONS

SIEMENS

	Item	Specifications	S840Dsl
			NHP 5500 2 nd generation
Controlled axis	Controlled axes	-	4 axes
	Simultaneously controlled axes	-	4 axes
Data input/output	Memory card input/output	(Local drive)	●
	USB memory input/output		●
Interface function	Ethernet	(X130)	●
Operation	On network drive	(without EES option, Extcall)	●
	On USB storage medium, e.g. memory stick	(without EES option, Extcall)	●
Program input	Workpiece coordinate system	G54 - G57	●
	Addition of workpiece coordinate system	G505 - G599	●
Interpolation & Feed function	Advanced surface		●
	Top surface		○
Programming & Editing function	Look ahead number of block	S/W version 4.8	1000
	3D simulation, finished part		●
	Simultaneous recording		●
	Measure kinematics		X
Operation Guidance Function	DXF Reader for PC integrated in SINUMERIK Operate		○
	ShopMill		●
Setting and display	EZ Work		●
	Operation via a VNC viewer		●
Network	MTConnect		⊕
	OPCUA		○
Etc. function	15.6" color display with touch screen		○
	19" color display without touch screen		○
	21.5" color display with touch screen		○
	CNC user memory	10 MB	●
	Expansion by increments	2 ~ 12 MB	○
	Collision avoidance		○
Collision avoidance ECO (machine, working area)		○	

● Standard ○ Optional X Not Available ⊕ Available

POWER | TORQUE

10000 r/min **FANUC**

MAX. SPINDLE POWER: **37/26** kW
49.6/34.9 Hp

MAX. SPINDLE TORQUE: **516** N·m
380.8 ft-lbs

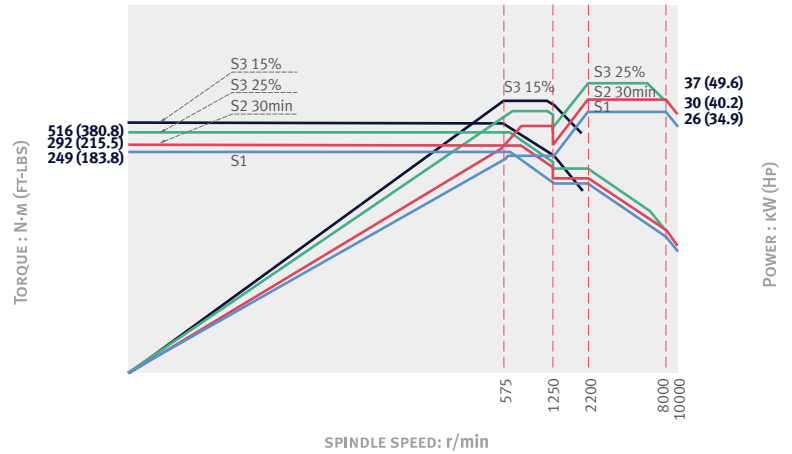

10000 r/min **FANUC** option

MAX. SPINDLE POWER: **46/26** kW
61.7/34.9 Hp

MAX. SPINDLE TORQUE: **644** N·m
475.3 ft-lbs

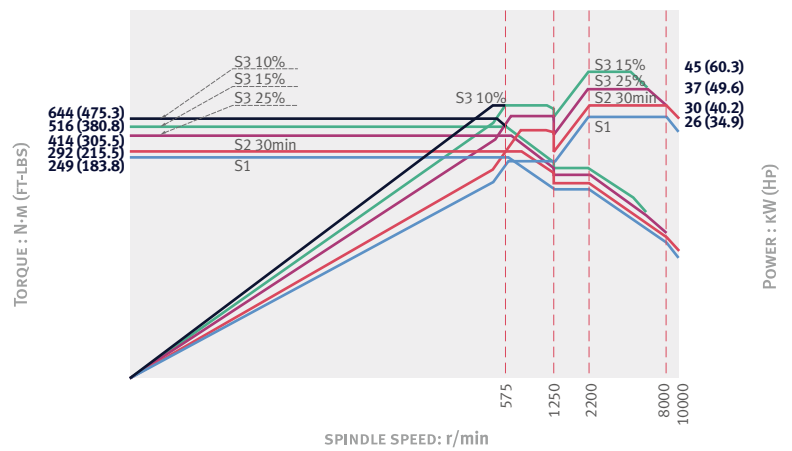

15000 r/min **FANUC** option

MAX. SPINDLE POWER: **37/30** kW
49.6/40.2 Hp

MAX. SPINDLE TORQUE: **398** N·m
293.7 ft-lbs

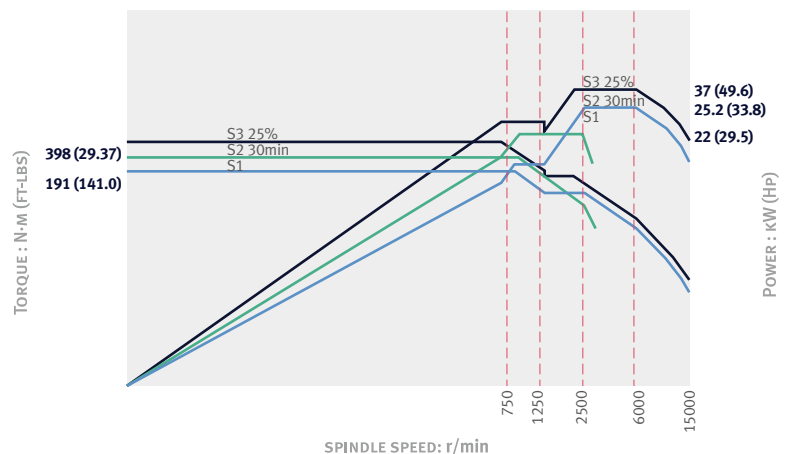

DIMENSIONS

Units : mm (inch)

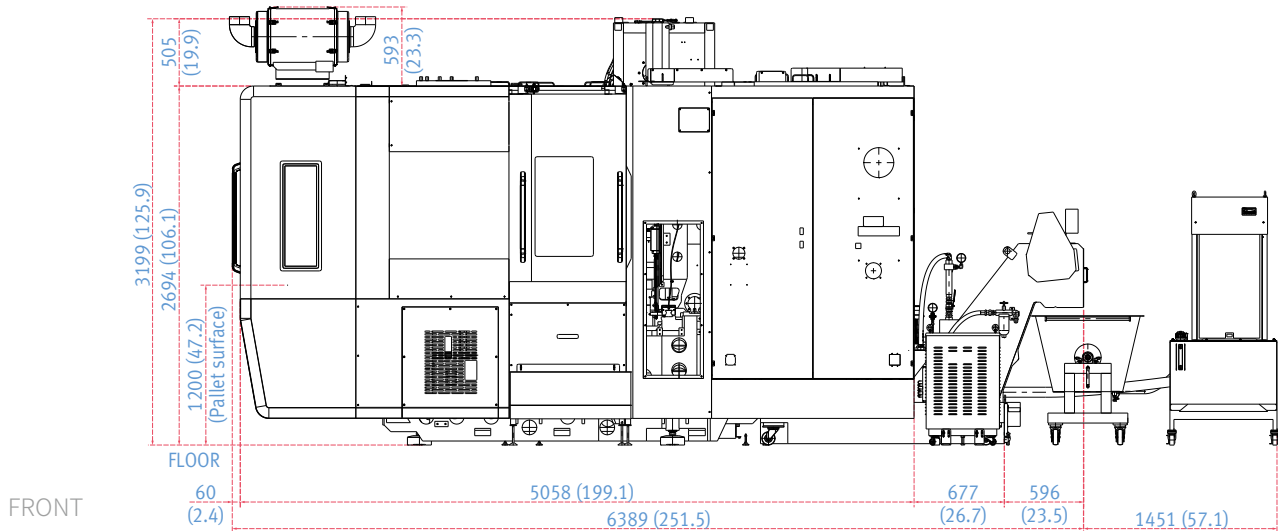
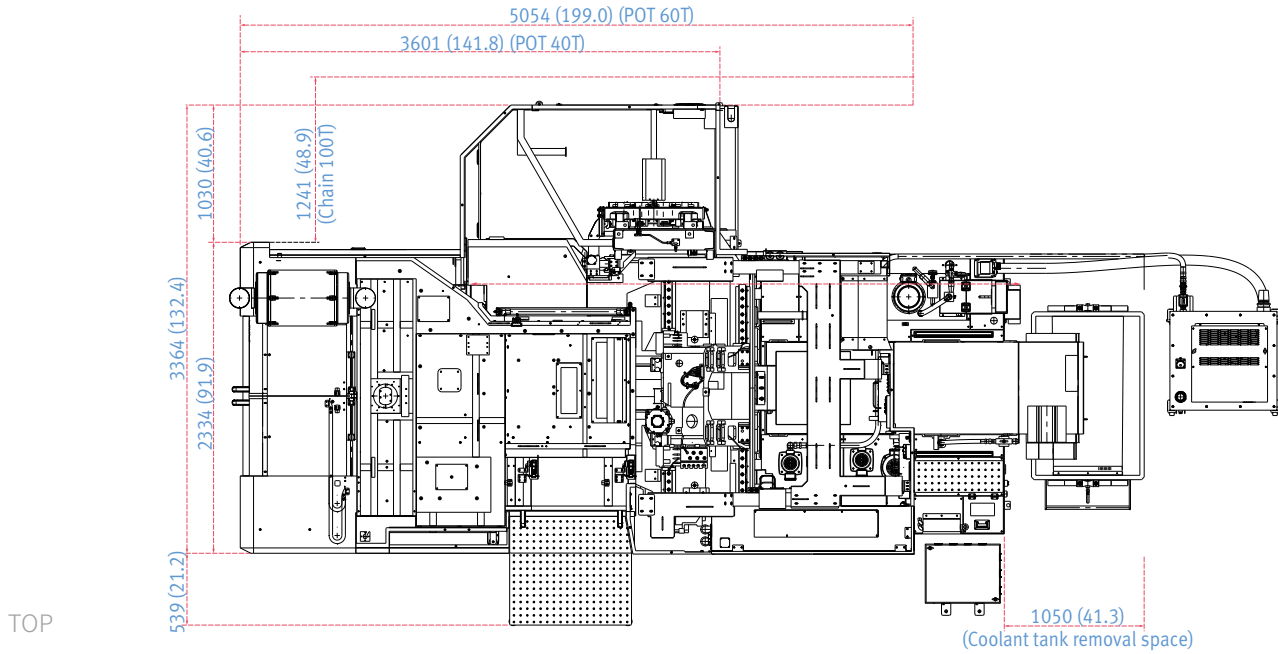

WORKING AREA

Table dimensions

Units : mm (inch)

STANDARD (500 × 500)

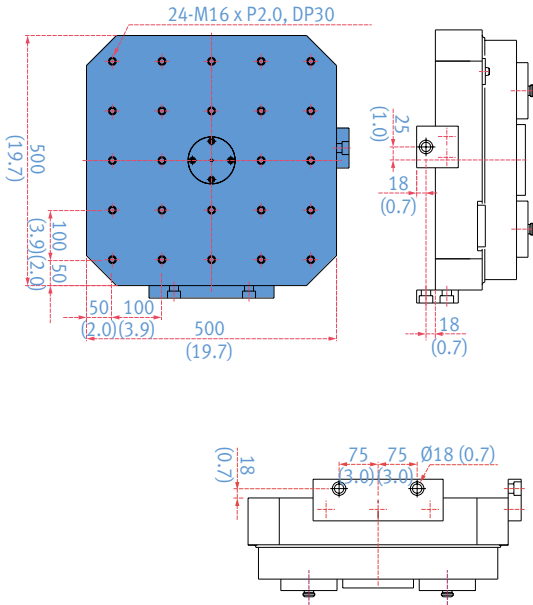

OPTION (630 × 630)

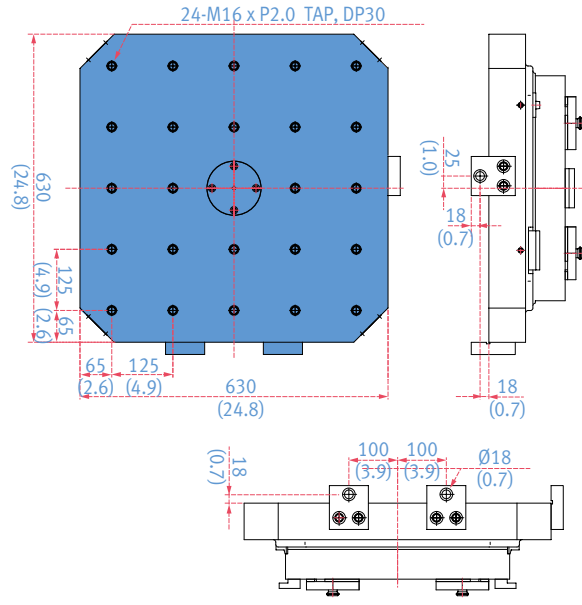

Workpiece working area

Units : mm (inch)

HSK100A

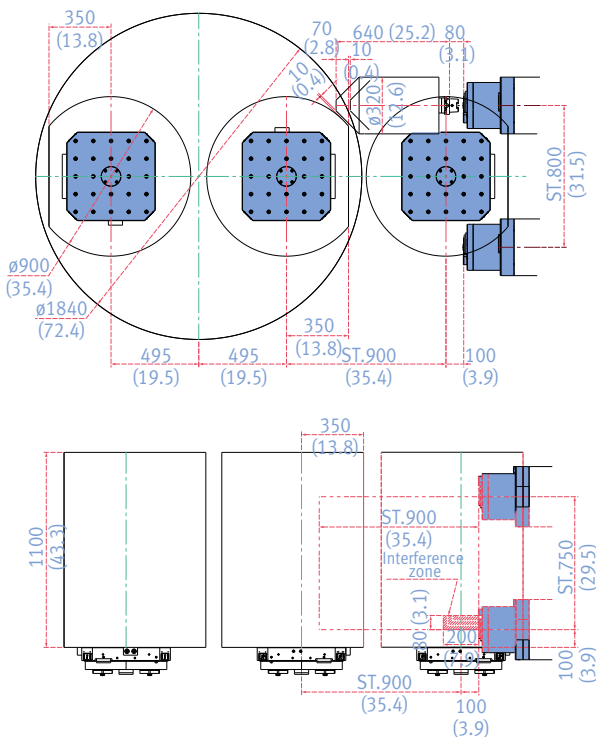

BT/CT/DIN

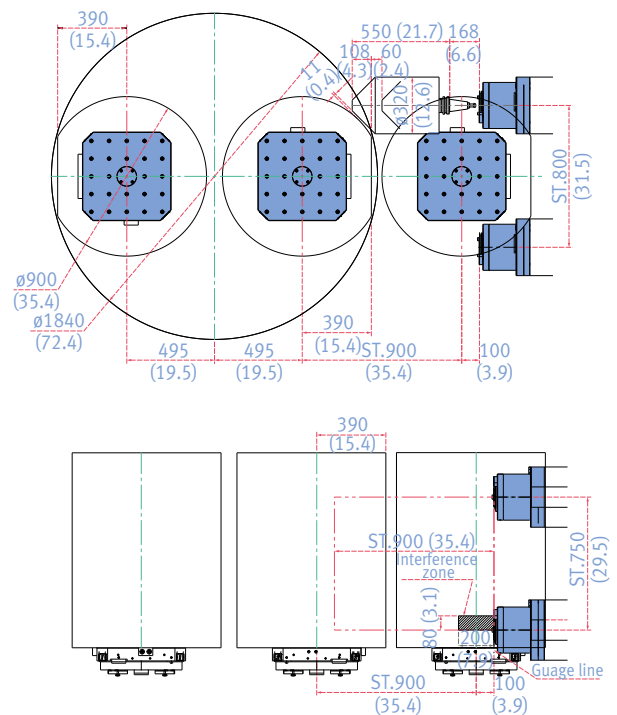

MACHINE SPECIFICATIONS

Description		Unit	NHP 5500 2 nd Generation	
Cutting capacity	Travel distance	X-axis	mm (inch)	800 (31.5)
		Y-axis	mm (inch)	750 (29.5)
		Z-axis	mm (inch)	900 (35.4)
	Distance from spindle nose to table center		mm (inch)	100~1000 (3.9~39.4)
	Distance from spindle center to table top		mm (inch)	100~850 (3.9~33.5)
Feed rate	Rapid feed rate	X-axis	m/min (ipm)	60 (2362.2)
		Y-axis	m/min (ipm)	60 (2362.2)
		Z-axis	m/min (ipm)	60 (2362.2)
	Cutting feed rate		mm/min (ipm)	30000 (1181.1)
Pallet	Pallet type			24-M16xP2.0
	Pallet indexing angle		deg	1 {0.001(DD, RGC)}
	Max. loading capacity		kg (lb)	800 {1000} (1763.7 {2204.6})
	Max. workpiece size		mm (inch)	Ø900 x 1100 (35.4 x 43.3)
	Pallet size		mm (inch)	500 x 500 (19.7 x 19.7)
Spindle	Max spindle speed		r/min	10000 {10000, 15000}
	Taper			ISO #50, 7/24 TAPER
	Max. torque		N·m (ft·lbs)	516 {644, 398} (380.8 {475.3, 293.7})
Auto pallet changer (APC)	No. of pallets		ea	2
	Pallet change time		s	12
	APC indexing angle (rotation)		deg	90
Automatic tool changer (ATC)	Type of tool shank			BT50 {CAT50,DIN50,HSK-A100}
	Tool storage capacity	Pot type	ea	40 {60}
		Chain type	ea	{90, 120, 150}
		Matrix type	ea	{196, 256, 316, 376}
	Max. tool diameter	W/O adjacent tool	mm (inch)	125 (4.9) (Pot type) 130 (5.1) (Chain/Matrix type)
		With adjacent tool	mm (inch)	320 (12.6)
	Max. tool length		mm (inch)	550 (21.7) (BT/CAT/DIN) 640 (25.2) (HSK)
	Max. tool weight		kg (lb)	25 {30} (55.1 {66.1})
	Max. tool moment		N·m (ft·lbs)	34.3 (25.3)
	Tool change time (tool to tool, tools)		s	1.7 (Less than 12kg)
Tool change time (chip-to-chip)		s	4.7 (Less than 12kg)	
Motor	Spindle motor power		kW (Hp)	37/30/26 (49.6/40.2/34.9) (S3 25%/30min/Continuous) {45/37/30/26 (60.3/49.6/40.2/34.9) (S3 15%/S3 25%/30min/Continuous), 37/30(49.6/40.2) (S3 25%/Continuous)}
Power source	Power consumption		kVA	66.99
	Compressed air pressure		Mpa	0.54
Tank capacity	Coolant tank capacity		L	1100
	Lubricant tank capacity		L	1.4
Machine dimensions	Height		mm (inch)	3199 (125.9)
	Length		mm (inch)	6389 (251.5) (Length with rear conveyor)
	Width		mm (inch)	3375 (132.9)
	Weight		kg (lb)	14000 (30864.3)

*{ } : option

The DN Solutions promise, MACHINE GREATNESS, has two important meanings. The first is simple: DN Solutions makes great machines. The second is a challenge to our end-users. With a product line that is this comprehensive, accurate and reliable, we equip our customers to machine greatness. The big question: *Why should you choose DN Solutions over other options?*

Here's why...



**MACHINE
GREATNESS™**



WHAT YOU MAKE AND HOW YOU MAKE IT MATTERS—SO MAKE IT
GREAT WITH DN SOLUTIONS.

UNBEATABLE MACHINES

You won't find a more comprehensive range or a better combination of value, performance and reliability anywhere else.

ROBUST PRODUCT LINE

We offer an impressive range of machine models and hundreds of configurations. Whatever your machining needs and requirements, there's a DN Solutions for you.

READILY AVAILABLE - ANYWHERE IN THE WORLD

Machining centres (including 5-axis machines), lathes, multi-tasking turning centres and mill-turn machines, and horizontal borers with best-in-class specifications are all available...ready to install.

EXPERT SERVICE

Our dedicated, experienced and knowledgeable team is totally committed to improving your productivity, growth and success.

CUSTOMER SUPPORT AND SERVICES

We're there for you whenever you need us.

We help our customers operate at maximum efficiency by providing them with a range of tried, tested and trusted services - from pre-sales consultancy to post-sales support.

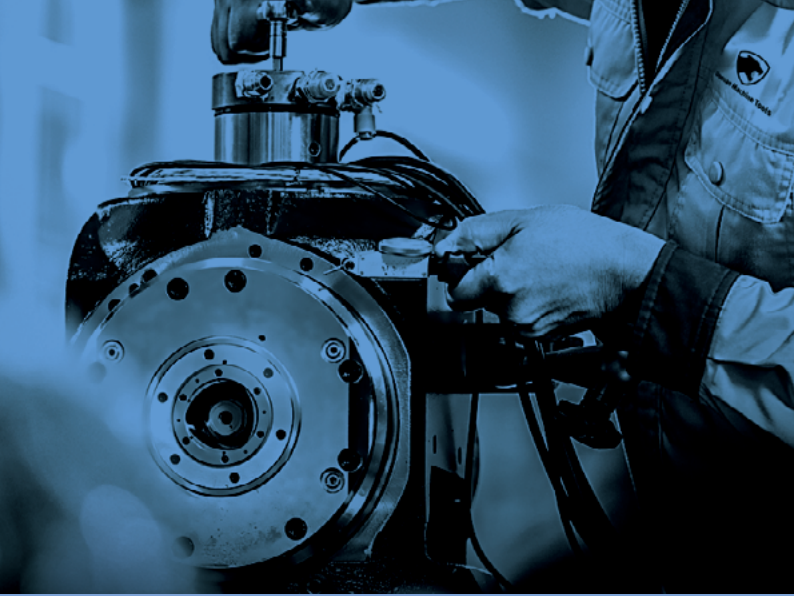

FIELD SERVICES

- On-site service
- Machine installation and testing
- Scheduled preventive maintenance
- Machine repair service

PARTS SUPPLY

- Supplying a wide range of original DN Solutions spare parts
- Parts repair service

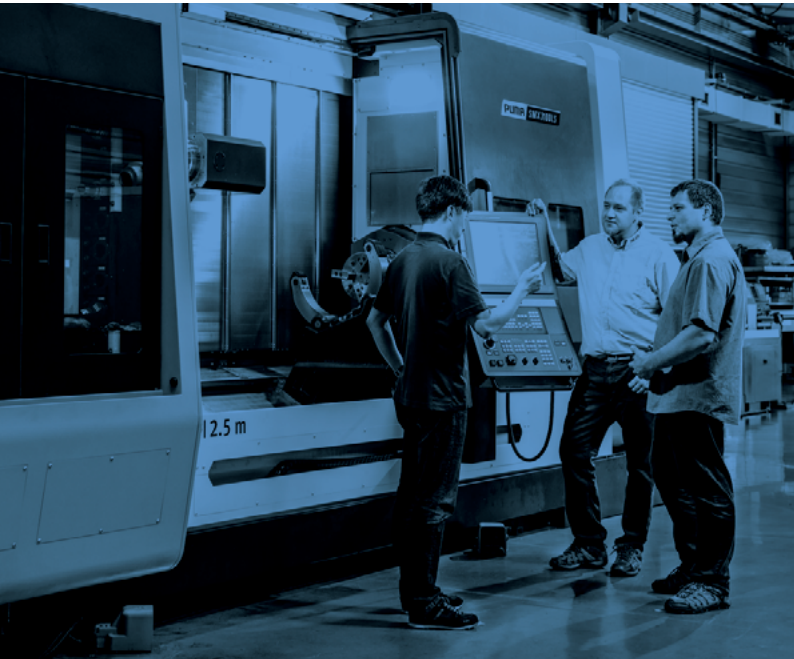

TRAINING

- Programming, machine setup and operation
- Electrical and mechanical maintenance
- Applications engineering

TECHNICAL SUPPORT

- Supports machining methods and technology
- Responds to technical queries
- Provides technical consultancy

RESPONDING TO CUSTOMERS ANYTIME, ANYWHERE

DN Solutions Global Network

DN Solutions provides systems-based professional support services, before and after the machine tool sale, by responding quickly and efficiently to customers. By supplying spare parts, product training, field service and technical support, we provide the expert care, attention and assistance our customers expect from a market leader.



Global sales and service support network

4	Corporations
156	Dealer networks
51	Technical centers Technical Center, Sales Support, Service Support, Parts Support
200	Service posts
3	Factories





dn-solutions.com

Head Office

22F T Tower, 30, Sowol-ro 2-gil
Jung-gu, Seoul, Korea, 04637

Tel: +82-2-6972-0370/0350
Fax: +82-2-6972-0400

DN Solutions America

19A Chapin Road, Pine Brook
New Jersey 07058, United States

Tel: +1-973-618-2500
Fax: +1-973-618-2501

DN Solutions Europe

Emdener Strasse 24, D-41540
Dormagen, Germany

Tel: +49-2133-5067-100
Fax: +49-2133-5067-111

DN Solutions India

No.82, Jakkuar Village
Yelahanka Hobli, Bangalore-560064

Tel: + 91-80-2205-6900
E-mail: india@dncompany.com

DN Solutions China

Room 101,201,301, Building 39 Xinzhuan
Highway No.258 Songjiang District
China Shanghai (201612)

Tel: +86 21-5445-1155
Fax: +86 21-6405-1472

Sales inquiry

sales@dncompany.com

* For more details, please contact DN Solutions.

* Specifications and information contained within this catalogue may be changed without prior notice.